

AR610 Blue Clean



Place
Stamp
Here

USE • MAINTENANCE MANUAL

A.R. North America
Attn: Pressure Washer Warranty Department
140 - 81st Avenue NE
Fridley, MN 55432

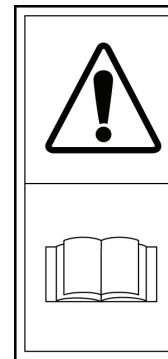

Warning: This manual must be read before installation or use of the unit.

WARNING: This product can expose you to chemicals including lead, DEHP, DINP which is known to the State of California to cause cancer and or lead to birth defects. For more information go to www.P65Warnings.ca.gov

PRECAUCIÓN: Este producto puede exponerle a los productos químicos incluyendo el plomo, DEHP, y DINP, que se saben al estado de California para causar el cáncer y/o defectos de nacimiento. Para más información, vaya a www.P65warnings.gov

PRESSURE WASHER LIMITED WARRANTY

This product is under warranty to the original retail consumer against defects in material and workmanship for a period of 1 (one) year and is a complete "bumper to bumper" warranty including the spray gun, the high-pressure hose and all accessories from the date of purchase. The warranty is not transferable or assignable. This warranty covers replacement parts. This limited one year warranty applies only to products used in consumer applications and is void in rental or any commercial application. Reasonable care must be used in conformity with operation and maintenance instructions in the owner's manual and quick start guide. Failure to follow these instructions will void this warranty.

WARRANTY RETURNS

Items returned for warranty consideration must have a Returned Merchandise Authorization (RMA) number. All unauthorized returns will be refused and shipped back to sender. Call 1-866-538-5112 Monday through Friday 8:00 a.m. - 5:00 p.m (Central Standard Time). Or E-Mail to: info@arnorthamerica.com 24 hours a day.

A.R. North America, Inc.

140 - 81st Avenue NE • Fridley, MN 55432
Attn: Pressure Washer Warranty Department

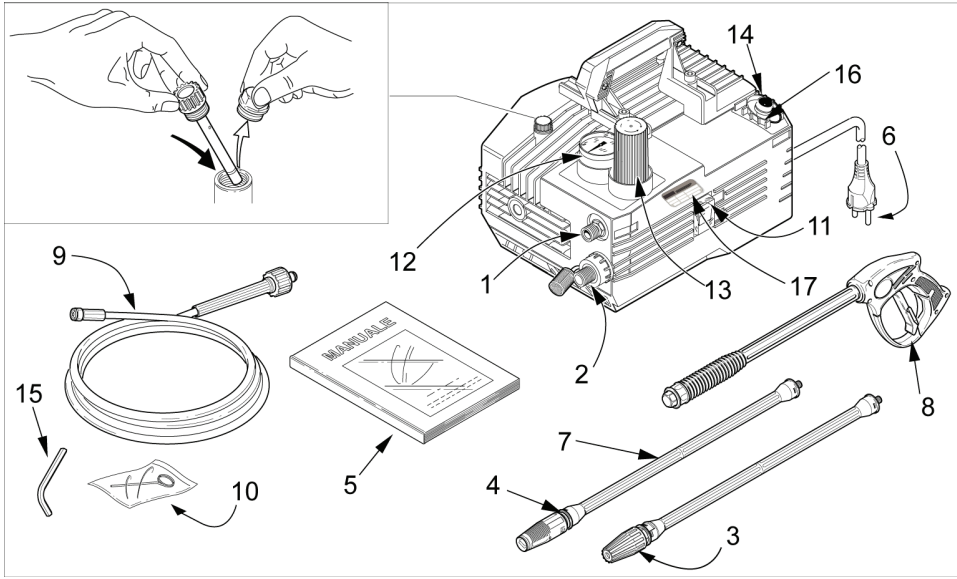

Key

- 1 - Water outlet (OUTLET)
- 2 - Water inlet with filter (INLET)
- 3 - High pressure rotating nozzle kit (optional accessory)
- 4 - Adjustable spray nozzle
- 5 - Maintenance handbook
- 6 - Power supply cable with plug
- 7 - Lance
- 8 - Gun with safety catch
- 9 - High-pressure hose
- 10 - Nozzle cleaning tool
- 11 - Motor switch
- 12 - Pressure gauge
- 13 - Pressure regulator knob
- 14 - Tank outlet plug
- 15 - Motor rotation key (for models with this feature)
- 16 - Detergent tank plug
- 17 - Data plate

Replace the red transportation cap with the oil filter cap dipstick.

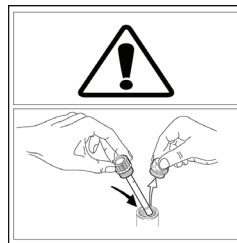

PRESSURE WASHER LIMITED WARRANTY CARD

Mr. Mrs. Ms. Miss

First Name: _____ Initial: _____ Last Name: _____

Address: (Number and Street) _____

Apt. #: _____

City: _____

State: _____ Zip/Postal code: _____

Telephone: _____

Date of Purchase: _____

Purchase Price: _____

Model Name: _____

Serial Number: _____

Located on product package/box

Store Name: _____

All fields must be filled out for warranty.
Warranty void from Manufacture if this card is not returned.

Notes

1. INTRODUCTION

















The high pressure power-jet cleaner you have purchased is a technologically advanced product designed by one of the leading European manufactures of high-pressure pumps. To obtain the best performance from your unit, read this booklet carefully and follow the instructions each time you use the cleaner. We congratulate you on your choice and wish you successful operation.





* Read and understand these instructions before operating the cleaner. Pay particular attention to the safety symbols through out this manual. Failure to comply with these instructions may result in personal injury or property damage. DO NOT allow children to operate or play on or around this equipment.

* Plug the cleaner into a properly grounded 3-prong outlet. Improper grounding can result in electrical shock.















2. SAFETY RULES

2.1 Safety “MUST NOTS”

- 2.1.1   DO NOT use the cleaner with flammable or toxic liquids, or any products, which are not compatible with the correct operation of the cleaner. EXPLOSION OR POISONING HAZARD.
- 2.1.2   DO NOT direct the water jet towards people or animals. INJURY HAZARD.
- 2.1.3   DO NOT direct the water jet towards the unit itself, electrical parts or towards other electrical equipment. ELECTRICAL SHOCK HAZARD.
- 2.1.4  DO NOT use the cleaner outdoors if raining. SHORT CIRCUIT HAZARD.
- 2.1.5  DO NOT allow children or incompetent persons to use the cleaner. INJURY HAZARD.
- 2.1.6   DO NOT touch the plug and/or socket with wet hands. ELECTRIC SHOCK HAZARD.
- 2.1.7   DO NOT use the cleaner if the electrical cable is damaged. ELECTRIC SHOCK AND SHORT CIRCUIT HAZARD.
- 2.1.8   DO NOT use the cleaner if the high-pressure hose or spray gun assembly is damaged. EXPLOSION HAZARD.
- 2.1.9  DO NOT jam or lock the spray gun trigger in the operating position. ACCIDENT HAZARD.
- 2.1.10  Check that the data plates are affixed to the cleaner, if not, contact your dealer. Cleaners without plates must NOT be used, as they are unidentifiable and potentially dangerous. ACCIDENT HAZARD.

- 2.1.11   Do not tamper with or alter the calibration of the safety valve. EXPLOSION HAZARD.
- 2.1.12  DO NOT alter the original diameter of the spray head nozzle. OVER PRESSURIZATION MAY OCCURE.
- 2.1.13  DO NOT leave the cleaner unattended. ACCIDENT HAZARD.
- 2.1.14  DO NOT move the cleaner by pulling on the electrical cable. SHORT CIRCUIT HAZARD.

2.2 Safety "MUSTS"

- 2.2.1  All electrical circuits MUST BE PROTECTED against the water jet. SHORT CIRCUIT HAZARD.
- 2.2.2  The cleaner MUST ONLY BE CONNECTED to a ground fault system. ELECTRIC SHOCK HAZARD.
 - Use of a safety residual current circuit-breaker (R.C.C.B.) will provide additional protection for the operator. (30 mA)
- 2.2.3   The high pressure may cause materials to bounce off surfaces at speeds; therefore protective clothing and safety goggles MUST BE WORN. INJURY HAZARD.
- 2.2.4   Before working on the cleaner, REMOVE the electrical plug. ACCIDENTAL START UP HAZARD.
- 2.2.5  Before pressing the trigger, GRIP the gun firmly to counteract the recoil. INJURY HAZARD.
- 2.2.6  COMPLY WITH the requirements of the local water supply company. According to DIN 1988, power-jet cleaners may only be connected to the mains drinking water supply with a backflow preventer valve with drain facility is installed in the supply hose. CONTAMINATION HAZARD.
- 2.2.7  A qualified technician MUST carry out maintenance and/or repair of the electrical components. ACCIDENT HAZARD.
- 2.2.8  DISCHARGE residual pressure before disconnecting the cleaner hose. Turn the water supply off and squeeze the spray gun trigger. INJURY HAZARD.
- 2.2.9  Before each use. CHECK that all the screws are fully tightened and that there are no broken or worn parts. ACCIDENT HAZARD.
- 2.2.10   Only USE detergents, which will not corrode the coating materials of the high- pressure hose/electrical cable and unit components. EXPLOSION AND ELECTRIC SHOCK HAZARD.
- 2.2.11   ENSURE that all people or animals keep a minimum distance of 16 yd. (15m) away. INJURY HAZARD.

Pos.	Code	Description	Qty.	Pos.	Code	Description	Qty.
1	1340700	Black post. casing	1	73	680700	Screw	1
2	1261560	Screw	2	74	480480	O-Ring	3
3	1260760	Screw	4	75	1340190	Cover	1
4	1200430	Screw	8	76	780050	O-Ring	1
5	1340811	Black plug	1	77	620301	Plug	1
6	1260351	Tank plug	1	78	1342670	Pump head	1
7	390210	O-Ring	1	79	851100	Grub	1
8	1342010	Black ant. casing	1	80	1250270	Spring	1
9	1342001	Black pres. gauge cover	1	81	1250280	Ball	1
10	1343250	Cable	1	82	3225	Pressure gauge	1
11	1340340	Bearing	1	83	1342700	Regulation valve seat	1
12	1340320	Rear cover	1	84	1460430	O-Ring	1
13	1260760	Screw	4	85	1460150	Lower piston	1
14	1260300	Fan	1	86	1343810	Valve seat	3
15	1340350	Seal	1	87	740290	O-Ring	5
16	1269100	Earth connection	1	88	1260670	Detergent fitting	1
17	1340780	Switch-box gasket	1	89	1342680	Head cover	1
18	1340480	Switch box	1	90	1381550	Washer	4
19	1263520	Capacitor 40µF	1	91	1343510	Screw	4
20	1263510	Capacitor 32µF	1	92	1080190	O-Ring	1
21	1263550	Capacitor 80µF	1	93	1460140	Upper piston	1
22	1341221	Switch 8A	1	94	1269115	Hose & filter	1
23	1263110	Switch 16A	1	95	1080401	Ring	1
24	1341140	Switch 8A gasket	1	96	1343450	Spring plate	1
25	1265080	Switch 16A gasket	1	97	1460190	Spring	1
26	1261560	Screw	4	98	1343000	Spring plate	1
27	1262370	Gland	1	99	1980640	Knob insert	1
28	1463860	Nut	1	100	1060120	Nut	1
29	1463850	Gland	1	101	392840	Grub screw	1
30	1260810	Screw	1	102	1322520	Knob	1
31	1340280	Clamp	1				
32	4380	Electric motor	1				
33	1260780	Screw	4				
34	1344060	Cover	1				
35	1040710	O-Ring	1				
36	1260050	Bushing	1				
37	1344050	Pump body	1				
38	1340050	Oil level	1				
39	1340300	Crankshaft	1				
40	880111	Key	1				
41	1341070	Roller bearing	1				
42	480890	Circlip	1				
43	111120	Circlip	1				
44	1341080	Seal	1				
45	1340060	Con-rod	3				
46	1340080	Pin	3				
47	1340070	Guiding piston	3				
48	1260460	Seal	3				
49	600180	O-Ring	4				
50	1341010	Spacer	3				
51	1342740	Piston	3				
52	1341020	Washer	3				
53	850670	Screw	3				
54	600180	O-Ring	1				
55	1349236	Pump assembly	1				
56	1260440	Gasket	3				
57	770260	O-Ring	3				
58	1342730	Piston guide	3				
59	1342760	Gasket	3				
60	1342720	Support ring	3				
61	1342750	Plate	3				
62	1349053	Complete valve	6				
63	800560	O-Ring	6				
64	390341	O-Ring	1				
65	1343110	O-Ring	1				
66	1342710	Nozzle	1				
67	1460430	O-Ring	1				
68	1460260	Piston	1				
69	1540140	Spring	1				
70	880270	O-Ring	1				
71	1342690	Outlet fitting	1				
72	550450	Ring nut	1				
	1340250	Hose tail	1				
	1340260	Filter	1				
	2605	Suction fitting	1				
	881470	Screw	4				

Repair Kits for Pump			
Water Seals	Valves	Pistons	Oil Seals
Kit 2624	Kit 1880	Kit 2623	Kit 1876
Pos. Qty.	Pos. Qty.	Pos. Qty.	Pos. Qty.
52 3	58 6	45 3	31 1
53 3	59 6	47 3	40 1
55 3		48 3	44 3
56 3			52 1
57 3			

O-Rings	
Kit 2767	
Pos.	Qty.
17	2
22	1
27	3
34	1
35	1
37	1
40	1
49	3
51	1
60	1
63	5
69	5
72	1

AR610

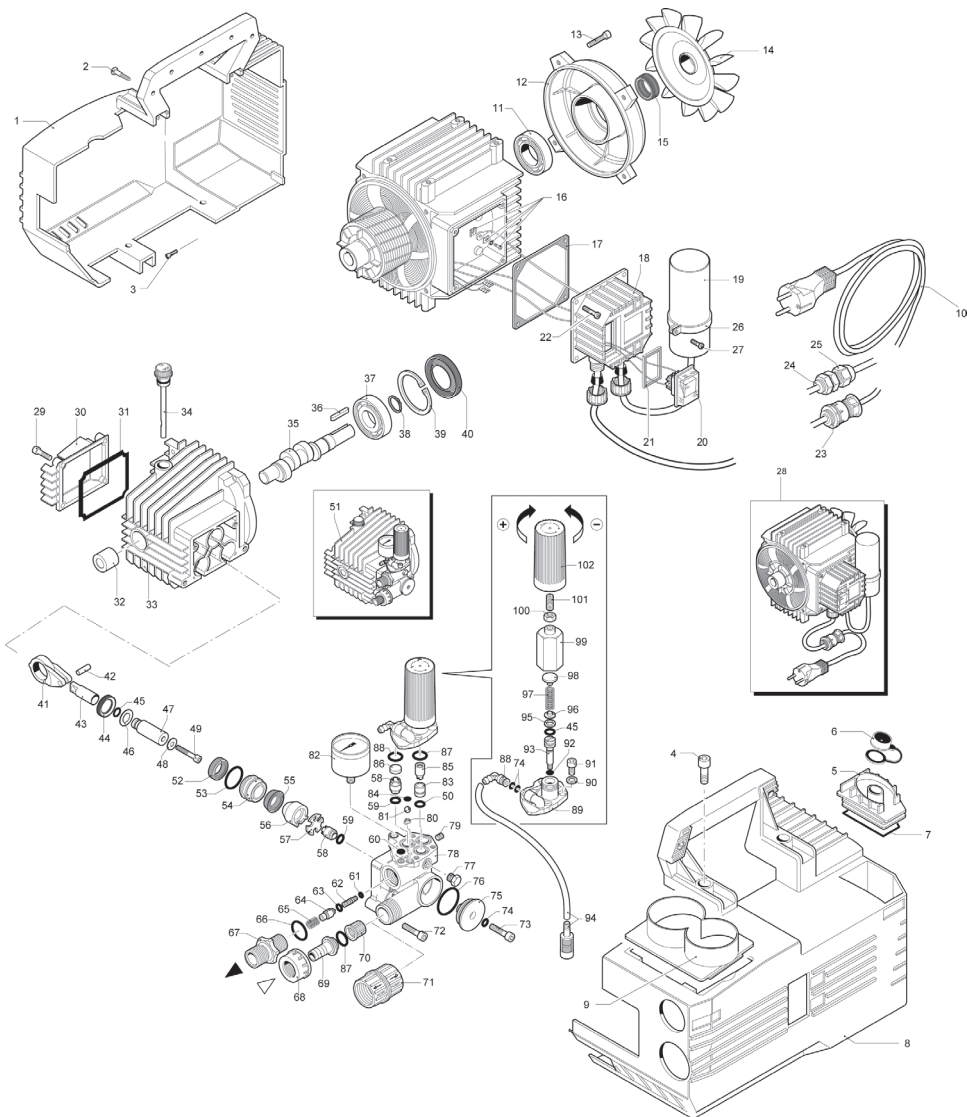

Always use two hands when operating a pressure washer. This will assure complete control of the equipment.

Always test the GFCI plug prior to using the cleaner.

Never test the pressure of the cleaner against any part of the body.

Use the trigger lock whenever the spray gun is not being used for cleaning.

Always seek emergency medical care immediately if any fluid penetrates the skin. A cut may be deeper and more serious than it appears.

3. GENERAL RULES

3.1.1 The USE and MAINTENANCE manual constitutes an essential part of the cleaner equipment and should be kept in a safe place for future reference. If you sell the cleaner, the manual should be handed on to the new owner.

3.1.2 Before starting the cleaner, make sure that it is receiving water correctly. Operating the cleaner without water could damage the seals.

3.1.3 Do not disconnect the plug by pulling on the electrical cable.

3.1.4 If you are too far from the object you wish to clean, do not move the cleaner nearer by pulling on the high pressure hose; use the handle provided.

3.1.5 Protect the cleaner from freezing during the winter. Store in a warm area.

3.1.6 Do not obstruct the ventilation grilles during operation.

3.1.7  **The cross-section of any extension cord used must be proportional to their length, i.e., the longer the extension cord, the greater the cross-section; cables with a protection level of "IPX5" must be used. See table A.**

Table A

	Voltage Volts	Extension cable up to 25 m	Extension cable up to 50m
Motor	220 – 230/240	Section 3x1.5mm ²	Section 3x2.5mm ²
	100 – 115/120	Section 3x2.5mm ²	Section 3x4mm ²

3.1.8 Position the cleaner AS NEAR AS POSSIBLE to the water supply.

3.1.9 The packaging is easily recyclable, and must be disposed of in compliance with the regulations in force in the country of installation.

- 3.1.10 Use the cleaner only with accessories and replacement parts authorized by the manufacturer. The use of original accessories and replacement parts will ensure safe, trouble-free operation.
- 3.1.11 The cleaner must be used standing on a secure, stable surface, positioned as shown.



3.2 Intended Use

- 3.2.1 The cleaner is intended only for the cleaning of vehicles, machines, boats, buildings, etc., by the removal of stubborn dirt using clean water and chemical detergents.
- 3.2.2 When using chemical detergents, only use biodegradable types. We recommend HOBBY – FOAM detergent (#3206).
- 3.2.3 Only clean vehicle engines in areas in which suitable oil traps are installed.

3.3 Safety Valve

- 3.3.1 The safety valve also functions as a pressure-limiting valve. When the gun trigger is released, the safety valve opens and the water recirculates through the pump inlet. Never try to adjust this valve.

Extension cords: up to 50' = 14AWG; 50' to 100' = 12AWG wire required.

4. INSTALLATION/ASSEMBLY

- 4.1  Fit the lance into the gun by rotating and pushing until the two parts are completely locked.

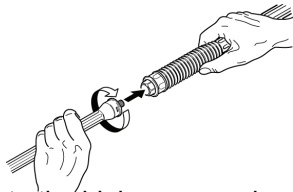

- 4.2 Connect the gun to the high-pressure hose.

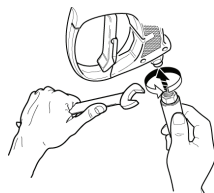

PROBLEMS AND REMEDIES	PROBLEM											REMEDIES
	The pump does not operate at the prescribed pressure.											
	Sudden changes in pressure.											
	Excess noise.											
	Water leakages.											
	Oil leaks.											
	Motor does not start											
	The motor buzzes but fails to start.											
	TSS MODELS ONLY. Motor starts even though the trigger is released.											
	TSS MODELS ONLY. No water when lever is operated (when supply hose is connected).											
	Power cord damage.											
CAUSE	Nozzle worn or wrong type.	✓										Replace nozzle.
	Water filter clogged.	✓										Clean filter.
	Water supply pressure low or no flow.	✓										Open the water supply tap fully. Check for nozzle blockage.
	Air being sucked into the system.	✓	✓									Check that hose fittings are tight.
	Air in pump.	✓										Switch off the cleaner and operate the gun until a steady flow of water is obtained. Turn the switch cleaner back on.
	Adjustable nozzle incorrectly positioned.	✓										Pull the spray adjuster back (+)
	Water suction from external tank.		✓									Connect the power-jet cleaner to the main water supply.
	Water temperature too high.		✓	✓								Lower temperature.
	Nozzle clogged.		✓							✓		Clean with tool provided.
	Air being sucked in.			✓								Check water inlet and outlet connections.
	Worn seals.				✓	✓						Fit new seals.
	Oil seals worn.					✓						Fit new seals.
	No electrical power (§)								✓			Check that the plug is firmly in the supply socket and that main power is present. Reset GFCI.
	Supply voltage below required minimum.									✓		Check the voltage of the main supply line.
	Voltage loss due to use of extension cord of inadequate cross-section or excessive length.									✓		Consult instructions regarding extension cords.
High pressure cleaner in disuse for extended period of time.									✓		Insert the key in the hole at the rear of the electric motor and unlock. (fig 6B)	
Sealing defects in high pressure system or water circuit.										✓	Contact nearest service center.	
TSS faults.								✓	✓		Contact nearest service center.	
Nozzle is clogged.										✓	Switch off power. Discharge pressure. Clean nozzle.	
										✓	Contact nearest service center.	

(§) If the motor stops and fails to restart, wait 2 - 3 minutes before restarting. THERMAL CUTOUT TRIPPED. If this fault occurs more than once, contact your service center.

More troubleshooting information on our website at www.arnorthamerica.com.

- 6.3 Long periods of non-use may lead to the formation of lime scale deposits. Working through the hole on the rear, **RELEASE** the motor using a screwdriver (for models with this feature). Then remove the screwdriver and proceed with the restart operations. - *Except for the Extreme* -

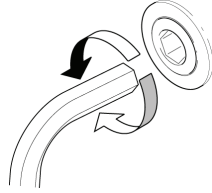

- 6.4 Clean the nozzle with the tool provided. Remove the lance from the gun; remove any dirt from the nozzle hole and rinse.

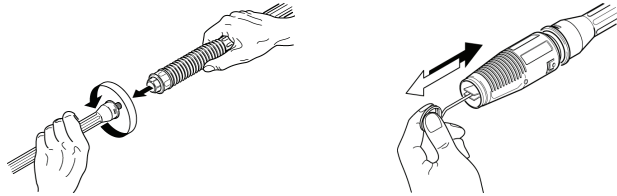

- 4.3 Connect the high-pressure hose to the water (OUTLET) on the cleaner.

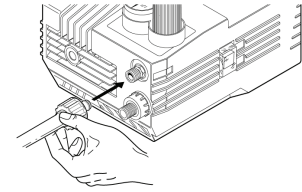

- 4.4 Connect the water supply hose. (not supplied) to the water (INLET) of the cleaner. The supply hose must have an internal diameter of at least 13 mm (1/2 in.) and must be reinforced. The water supply must be at least equal to the cleaner delivery capacity.

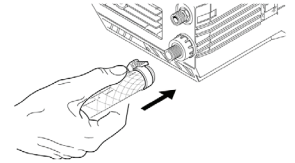

The intake water temperature must NOT exceed 60° C (122°F). The water supply pressure must NOT exceed 10 BAR (145 PSI).

- 4.4.1  **CAUTION! The cleaner must only be used with clean water; use of unfiltered water or corrosive chemicals will damage the cleaner.**
- 4.5 Turn the motor switch to the "0" position.

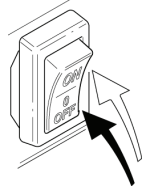

- 4.6 Check that the electrical supply voltage and frequency (Volts/ Hz) correspond those specified on the cleaner data plate.
- 4.6.1 If the motor stops and fails to restart, wait 2 to 3 minutes before restarting. **THERMAL CUTOUT TRIPPED AND MUST COOL BEFORE RESTARTING.**

AR610 models: These cleaners are packaged with a red shipping plug in the pump crankcase, this red plug must be removed and the black dipstick cap installed.

5. USE

- 5.1 Turn on the water supply to FULL flow.
- 5.2 **Release the safety catch, then press the trigger for a few seconds to allow air to escape and to discharge residual pressure in the pipes.**

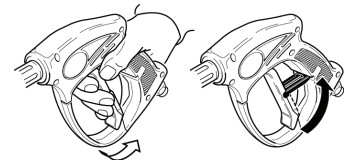

5.3 Pull the spray gun trigger; push the switch start the motor.

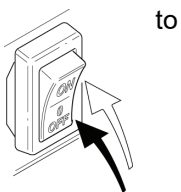

5.3.1 When re-starting the motor, always keep the spray gun trigger compressed.

TSS Models: In TSS models, with automatic delivery flow cut-off: when the trigger is released, the dynamic pressure automatically cuts out the motor. When the trigger is compressed the pressure drop automatically starting the motor and the pressure is restored with a very slight delay. For correct operation of the TSS, once the trigger has been released it must not be pressed again for at least 4 – 5 seconds. For correct use of the TSS model cleaner, do not leave the unit in automatic cut-off status for more than 15 min.

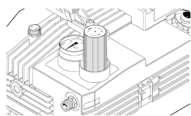

5.4 Using Detergent

5.4.1 CAUTION: liquid detergent must be sprayed at low pressure. See 5.5 “Proper use of standard accessories.”

5.4.2  Fill the detergent tank to the level indicated through the inlet.

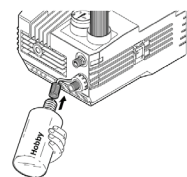

5.4.3 Select LOW PRESSURE (see instructions); the detergent will be sucked up and mixed with the water, with the suction rate regulated by the knob provided. (Model not fitted with detergent control knob).

5.4.4 Now distribute the detergent drawn in and mixed with water.

5.5 Correct Use of standard accessories. (Where fitted)

5.5.1 The cleaner is equipped with the adjustable nozzle, which provides some important functions:

5.5.2 LOW PRESSURE operation (for suction and spraying of detergent).

5.5.3 HIGH PRESSURE operation (for high pressure washing and rinsing).

5.5.4 Jet adjustment from pencil to fan. (For models with this feature).

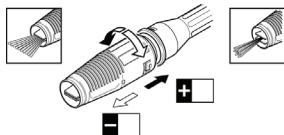

5.6 Correct Use of the Rotary Nozzle (Where fitted)

5.6.1 For increased washing power, use the rotary nozzle kit as follows:

5.6.2 Turn off the high pressure cleaner.

5.6.3 Unscrew the adjustable head and fit the rotary nozzle onto the lance.

5.6.4 Turn the high pressure cleaner back on.

5.7 Recommended Cleaning Procedure

5.7.1 Dissolve dirt by applying detergent with the fan jet to the dry surface.

On vertical surfaces, work from the bottom upwards. Leave the detergent to act for 1 to 2 minutes, but do not allow to dry out. Apply the high pressure jet, keeping the nozzle at least 10 in. from the surface, working from the bottom upwards. Avoid allowing the rinsing water to run on the unwashed surfaces.

5.8 Storage

5.8.1 Switch off the cleaner.

5.8.2 Turn off the water supply tap.

5.8.3 After use, the detergent residues should be removed from the tank.

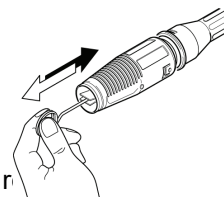

5.8.4 Discharge the detergent by pressing the trigger until no more water comes out of the adjustable nozzle.

5.8.5 Engage the gun safety catch.

5.8.6 Remove the plug from the socket.

5.8.7 Operate the cleaner with non-corrosive/non-toxic antifreeze before storing for the winter.

6 MAINTENANCE

6.1 CAUTION! Before working on the cleaner, disconnect the plug from the power supply socket.

6.2 To ensure good performance, check and clean the suction and detergent filters after every 50 hours of operation.

